

niglon

Circuit Protection

PCU1816M Isolator Controlled Consumer Unit Right hand Incomer



Technical Drawing

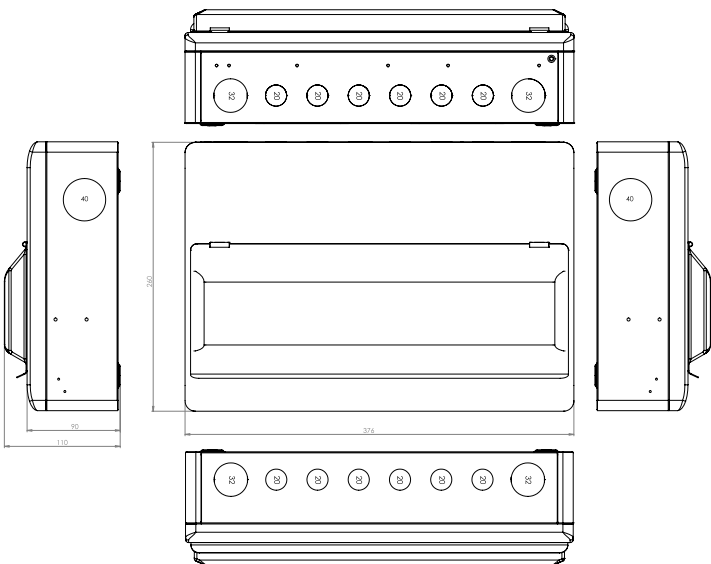

Technical Specifications

Material Composition	Steel (Powder Coated)
Configurations	18 Module 16 Free Ways 100A DP Isolator
Rated Operational Voltage (Un/Ue)	230V AC
Rated Current of Assembly (InA)	100A
Rated Frequency	50Hz
Main Switch Terminal Capacity	35mm ²
IP Rating (Ingress Protection)	IP20
IK Rating (Impact Protection)	IK05
Dimensions	376 (W) x 260 (H) x 110mm (D)
Standards	BS7671:2018, BS EN61439-3
100A Mains Isolator Manufactured to	EN60947:3
Certification	Semko, CE, UKCA

All specifications are SEMKO Certified